

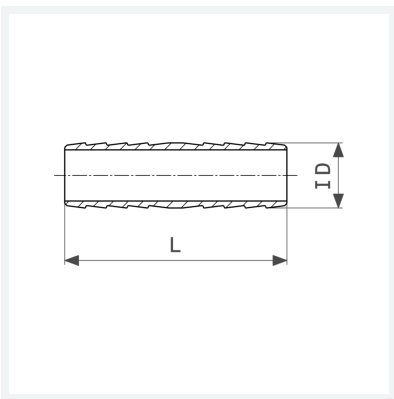

Schlauchverbinder
- Ausführung schwer
Modell 1852

Artikel 108 632



Eigenschaften

Für ID-Schlauch	ID	$\frac{3}{4}$
Länge	L	55 mm
Gewicht	41,5 g	
Volumen	49,728 cm ³	
Werkstoff	Messing	