

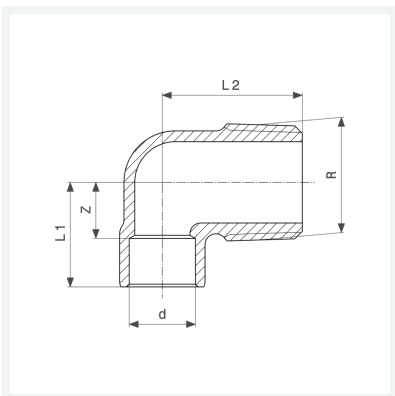

Übergangswinkel 90°
- Lötanschluss, R-Gewinde
Modell 94092G

Artikel 100 568



Eigenschaften

Rohraußendurchmesser	d	15
Außengewinde kegelig	R	½
Z-Maß	Z	10 mm
Länge 1	L1	21 mm
Länge 2	L2	28 mm
Gewicht	40,4 g	
Volumen	49,728 cm ³	
Werkstoff	Rotguss	