

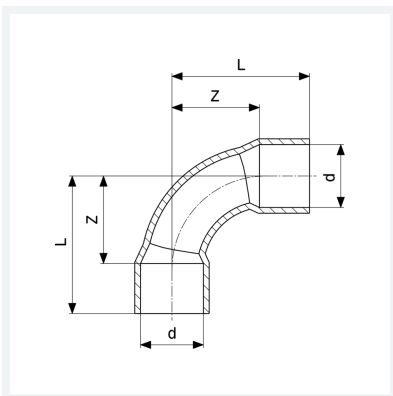

**Bogen 90°**  
- Lötanschluss  
**Modell 95002A**

**Artikel 100 018**



## Eigenschaften

Gütesicherung Cu	Cu	✓
Rohraußendurchmesser	d	15
Z-Maß	Z	18 mm
Länge	L	29 mm
Gewicht	17,8 g	
Volumen	34,6 cm <sup>3</sup>	
Werkstoff	Kupfer	