

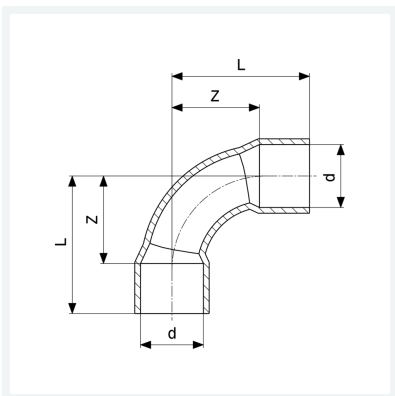

Bogen 90°
- Lötanschluss
Modell 95002A

Artikel 100 193



Eigenschaften

Gütesicherung Cu	Cu	✓
Rohraußendurchmesser	d	28
Z-Maß	Z	33 mm
Länge	L	52 mm
Gewicht	81,2 g	
Volumen	173,2 cm ³	
Werkstoff	Kupfer	