

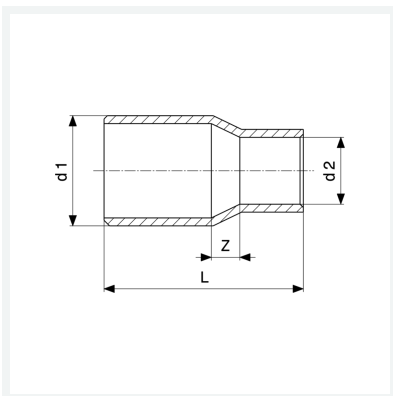

Reduzierstück
- Einsteckende, Lötanschluss
Modell 95243

Artikel 105 983



Eigenschaften

Rohraußendurchmesser 1	d1	15a
Rohraußendurchmesser 2	d2	10
Z-Maß	Z	3 mm
Länge	L	23 mm
Gewicht	8,3 g	
Volumen	15,54 cm ³	
Werkstoff	Kupfer	