

Datenblatt

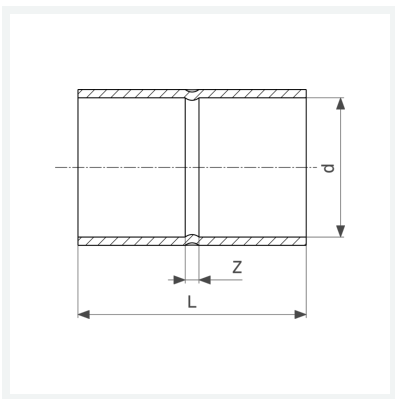

Muffe
- Lötanschluss
Modell 95270

Artikel 100 117



Eigenschaften

Gütesicherung Cu	Cu	✓
Rohraußendurchmesser	d	15
Z-Maß	Z	2 mm
Länge	L	23 mm
Gewicht	8,15 g	
Volumen	24,864 cm ³	
Werkstoff	Kupfer	