

# Datenblatt

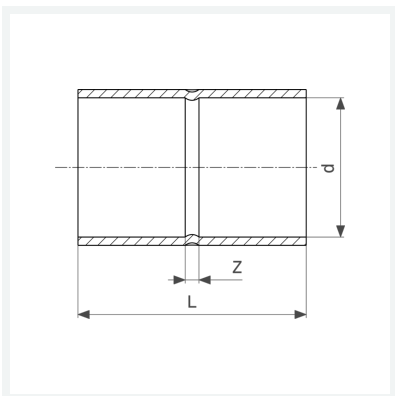

**Muffe**  
- Lötanschluss  
**Modell 95270**

**Artikel 105 433**



## Eigenschaften

Gütesicherung Cu	Cu	✓
Rohraußendurchmesser	d	42
Z-Maß	Z	2 mm
Länge	L	56 mm
Gewicht	85,3 g	
Volumen	248,64 cm <sup>3</sup>	
Werkstoff	Kupfer	