

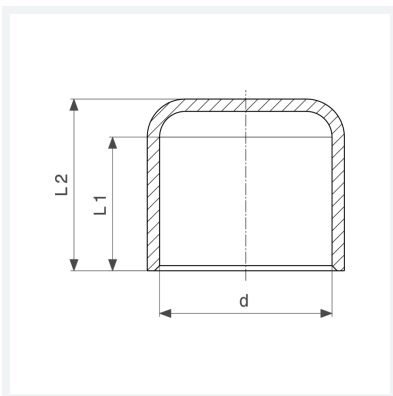

**Kappe**  
- Lötanschluss  
**Modell 95301**

**Artikel 108 892**



## Eigenschaften

Rohraußendurchmesser	d	10
Länge 1	L1	8 mm
Länge 2	L2	10 mm
Gewicht	4,1 g	
Volumen	7,313 cm <sup>3</sup>	
Werkstoff	Kupfer	