

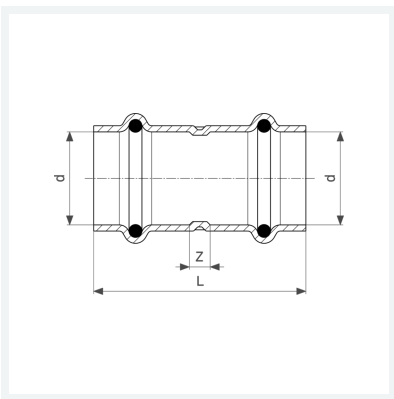

**Profipress G-Muffe
mit SC-Contur**
- Pressanschlüsse
Ausstattung
Dichtelemente HNBR
Modell 2615

Artikel 346 492



Eigenschaften

Rohraußendurchmesser	d	18
Z-Maß	Z	5 mm
Länge	L	49 mm
Gewicht	45,2 g	
Volumen	99,456 cm ³	
Werkstoff	Kupfer	