

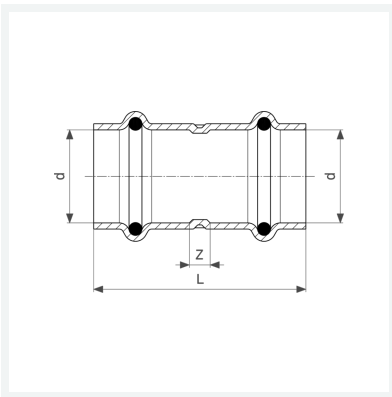

**Profipress G-Muffe
mit SC-Contur**
- Pressanschlüsse
Ausstattung
Dichtelemente HNBR
Modell 2615

Artikel 347 055



Eigenschaften

Rohraußendurchmesser	d	12
Z-Maß	Z	3 mm
Länge	L	39 mm
Gewicht	26,25 g	
Volumen	82,88 cm ³	
Werkstoff	Kupfer	