



## Sanpress Inox G-Bogen 90° mit SC-Contur

- Pressanschlüsse

### Ausstattung

Dichtelemente HNBR

**Modell 0216**

**Artikel 485 825**

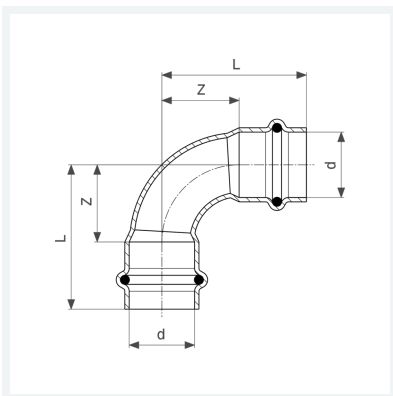

## Eigenschaften

Rohraußendurchmesser	d	35
Z-Maß	Z	33 mm
Länge	L	59 mm
Gewicht	161,5 g	
Volumen	828,8 cm <sup>3</sup>	
Werkstoff	Stahl nichtrostend	