

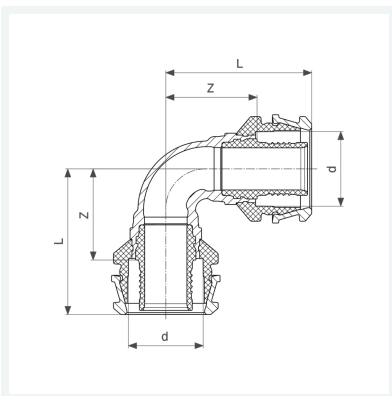

**Raxofix-Bogen 90°
mit SC-Contur**
- Pressanschluss
Modell 5316

Artikel 647 025



Eigenschaften

Rohraußendurchmesser	d	25
Z-Maß	Z	30 mm
Länge	L	50 mm
Gewicht	139 g	
Volumen	248,64 cm ³	
Werkstoff	Siliziumbronze	