

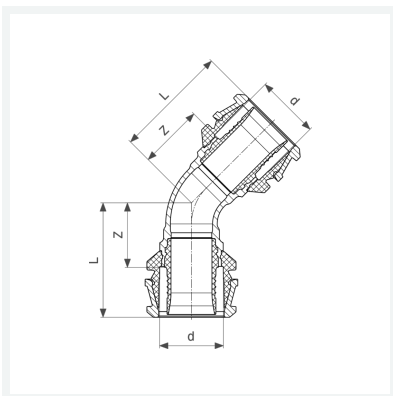

**Raxofix-Bogen 45°
mit SC-Contur**
- Pressanschluss
Modell 5326

Artikel 647 100



Eigenschaften

Rohraußendurchmesser	d	50
Z-Maß	Z	40 mm
Länge	L	67 mm
Gewicht	562 g	
Volumen	1243,2 cm ³	
Werkstoff	Siliziumbronze	