

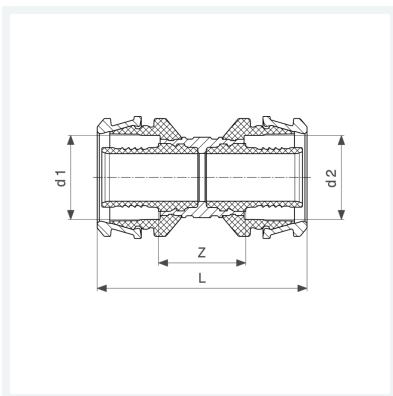

**Raxofix-Kupplung
mit SC-Contur**
- Pressanschluss
Modell 5315

Artikel 646 820



Eigenschaften

Rohraußendurchmesser 1	d1	20
Rohraußendurchmesser 2	d2	16
Z-Maß	Z	22 mm
Länge	L	52 mm
Gewicht	47,6 g	
Volumen	99,456 cm ³	
Werkstoff	Siliziumbronze	