

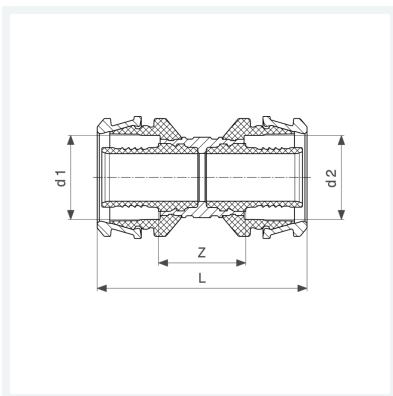

**Raxofix-Kupplung
mit SC-Contur**
- Pressanschluss
Modell 5315

Artikel 646 851



Eigenschaften

Rohraußendurchmesser 1	d1	25
Rohraußendurchmesser 2	d2	20
Z-Maß	Z	25 mm
Länge	L	59 mm
Gewicht	86,16 g	
Volumen	124,32 cm ³	
Werkstoff	Siliziumbronze	