

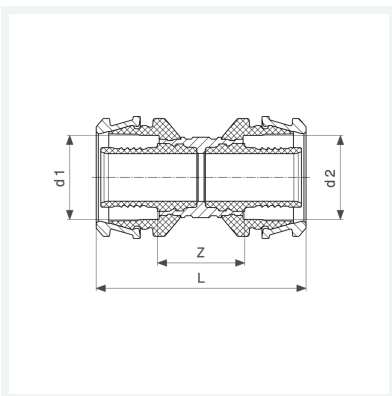

**Raxofix-Kupplung  
mit SC-Contur**  
- Pressanschluss  
**Modell 5315**

**Artikel 646 912**



## Eigenschaften

Rohraußendurchmesser 1	d1	50
Rohraußendurchmesser 2	d2	50
Z-Maß	Z	39 mm
Länge	L	91 mm
Gewicht	450,5 g	
Volumen	828,8 cm <sup>3</sup>	
Werkstoff	Siliziumbronze	